



POLYPROPYLENE
MINERAL REINFORCED
PP-MD SYSTEMS
Technical Manual



almona SEWAGE & DRAINAGE



Only products bearing the NSF, SASO, WRAS, DVGW and SKZ Mark are certified by those organizations.



almonaplast.com

// WE DESIGN, DEVELOP, MANUFACTURE
AND PROVIDE INNOVATIVE PIPE
SOLUTIONS THAT BEST MEET THE
NEEDS OF OUR CUSTOMERS //

ABOUT US

Almona is a leading Saudi Arabian plastic pipe manufacturing company and since our establishment in 2008 we have constantly evolved to meet the requirements of our most demanding customers. Our aim is to provide sophisticated and diverse pipe solutions for hot and cold water applications, telecommunication networks, sewage and drainage systems together with water and gas infrastructure.

We are a certified to ISO 9001:2015 Quality Management Systems organization and all our products comply with the appropriate Saudi (SASO), German (DIN) and International (ISO) Standards. Our pipe systems for drinking water applications are NSF-61, WRAS and DVGW certified and all almona products are tested extensively in our state-of-the-art laboratory, to ensure that the quality and performance are continuously maintained.

Almona's success is the result of the company's persistent commitment to continuous innovation and investment in technology, in the relentless pursuit of providing quality products and services. Today, we are pleased to offer a wide range of plastic products, divided into four categories:



BUILDINGS



SEWAGE AND
DRAINAGE



INFRASTRUCTURE



TELECOMMUNICATION
DUCTING

almona PPMD fittings

// THE SIGNIFICANT ADVANTAGES OF POLYPROPYLENE, OVER THE TRADITIONAL PIPE SYSTEMS, MAKES ALMONA PP-MD SYSTEMS THE FIRST-CHOICE MATERIALS FOR YOUR DRAINAGE AND SEWERAGE NETWORKS //



CONTENTS

This manual is intended for civil designers, engineers, contractors and installers of drainage and sewerage pipe systems. It is divided into seven sections as follows:

Section I:	General Information	06
Section II:	Technical Specifications	09
Section III:	The High Stiffness and Low Noise Mineral Filled System Concepts	11
Section IV:	Product Range	14
Section V:	Installation	17
Section VI:	Storage and Handling	23
Section VII:	Appendix	24

Section I

1. General Information

1.1 Introduction

Almona offers a wide product range of reinforced polypropylene (PP-MD) non-pressure pipes and fittings with mineral modifiers for use in drainage and sewerage networks installed both underground and within buildings. The pipes and fittings systems are specially designed to have high stiffness and impact performance, together with being operate at low and high temperatures.

The almona systems comply with the below application area codes, according to EN 14758 and DIN EN 1451-1:

- Application area code "UD": underground drainage and sewerage outside the building structure (application area code "U") and non-pressure underground drainage and sewerage for both buried in ground within the building structure (application area code "D") and outside the building structure.
- Application area code "BD": soil and waste discharge systems (low and high temperatures) within the building structure (application area code "B") as well as buried in the ground (application area "BD"); construction of ventilation, rainwater drainage and vacuum systems inside the building structure (application area code "B").

Almona PP-MD systems, are manufactured in our ISO 9001:2015 accredited production facilities, using only the highest quality raw materials available from internationally renowned suppliers following highly controlled manufacturing processes and technologies. Our products are approved to the most stringent internal, national and international standards, for delivering high quality, comprehensive service and products to be used with confidence for your drainage and sewerage networks.

1.2 Advantages of the System

Almona systems are designed to be used in highly demanding applications, such as drainage and sewerage networks where the advantages of thermoplastics are desirable and a high level of rigidity is also required. The main advantages of almona system are summarized below:

- Resistant to chemicals such as acids, alkalis and salts, ranging from pH2 to pH12.
- Resistant to flames and fire propagation.

- Fast and easy installation.
- Triple layer technology meets the requirements of applications area codes "UD" and "BD", according to EN 14758 and DIN EN 1451-1.
- High resistance to waste water temperatures up to 90°C (peak 95°C).
- Produced from non-toxic, halogen free material.
- Leak free system due to innovative 3 lip system (tensioning and retaining lip, wiping lip and sealing lip).
- Noise reduction due to 3-layer technology and innovative PP-MD material.
- Installation possible at low temperatures.
- Transition to PVC and HDPE system possible without additional transition fittings.
- Resistant to ground movement and earthquakes due to high system flexibility, thanks to rubber ring joints.

The significant advantages of polypropylene, over the traditional pipe systems, makes Almona PP-MD systems the first-choice materials for your drainage and sewerage networks. For more detailed information on the key characteristics and advantages of PP-MD system, refer to Section II and Section III of this document.

1.3 Characteristics of the System

Almona non-pressure drainage and sewage pipes are manufactured using 3-layer technology, described below:

- Outer layer is made of polypropylene (PP) material combining high impact/stiffness balance with a smooth surface. The outer layer possesses high elasticity and hard top surface, which makes it highly resistant to penetration of rigid objects (e.g. rocks) in the pipe wall. Addition of a specialized stabilisation package provides high UV protection, which allows outdoor storage.
- Middle layer is made of reinforced mineral polypropylene (PP-MD) which combines a high stiffness, improved thermal expansion coefficient and sound attenuation.
- Inner layer is made of polypropylene (PP) which is specially designed to prevent chemical attack and corrosion, to be resistant to high temperature (up to 95°C) and to prevent flow restrictions of the waste water.

The almona three-layer technology guarantees long operational life, low maintenance and water tightness of the PP-MD drainage and sewage networks. The fittings are made of mineral reinforced polypropylene which provides a high stiffness/impact balance in combination with improved dimensional stability.

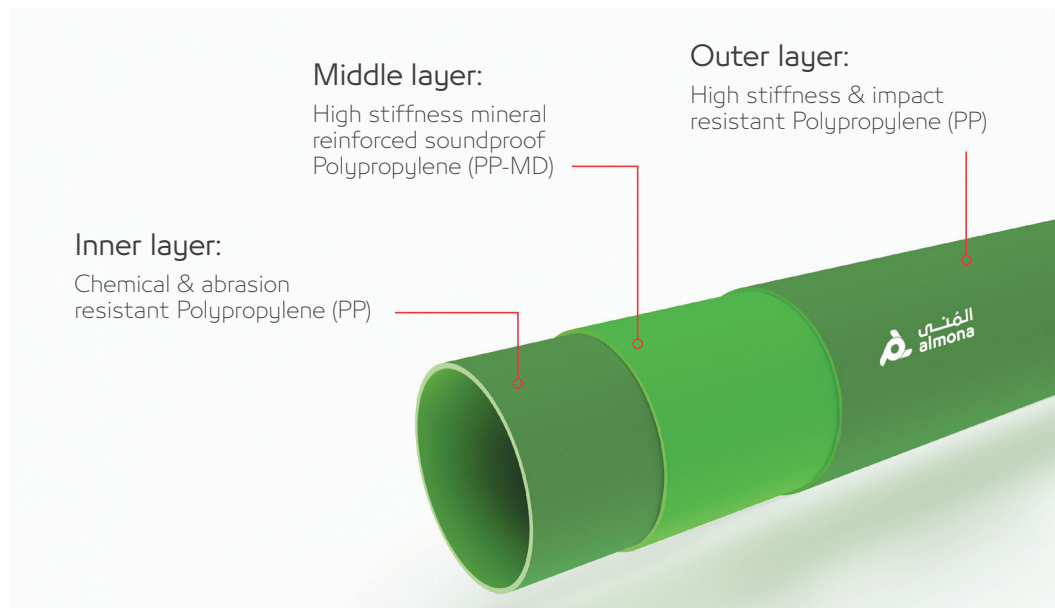

Almona PP-MD systems are long lasting water-tight against leakage of waste water and ground water thanks to 3-lips innovative design of rubber sealing gasket. The rubber sealing systems consists of:

- Tensioning and retaining lip prevents dirt build-up between the pipe wall and the rubber gasket and stop the rubber gasket from being pressed out or rolling during push fit connection.
- Wiping lip keeps back any dirt on the pipe during the connection.
- Sealing lip assures a thing long-term connection.

The insertion forces are considerably reduced by the special 3 lips rubber gasket design which makes the installation of almona systems easier compared to standard drainage and sewer pipe systems.

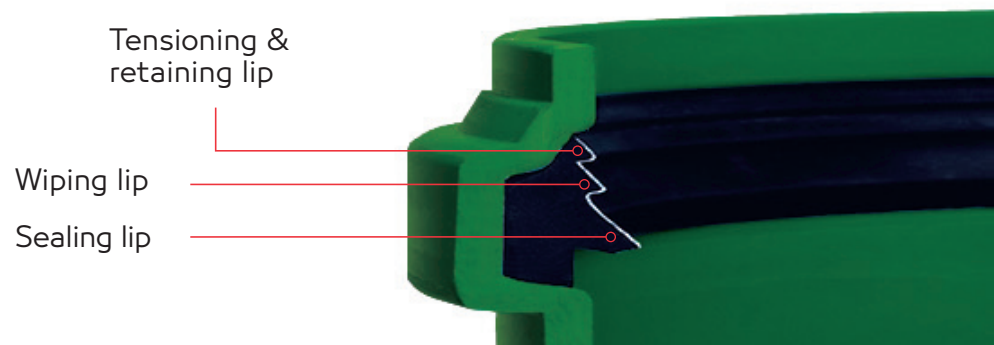

Section II

2.1 Pipe and Fittings Specification

Almona offers a complete range of mineral reinforced polypropylene drainage and sewage pipes and fittings with the following characteristics:

- **Size Range:** Nominal Diameter (DN) 32, 40, 50, 75, 90, 110, 125, 160 and 200 mm, 125, 160 and 200 mm, 125, 160 and 200 mm,
- **Color:** Green RAL 6017
- **Joining Method:** Push-Fit with innovative 3-lips elastomeric rubber seal

Physical properties of almona pipes and fittings:

Characteristics	Requirements of EN 14758-1	Test method
impact resistance	TIR \leq 10% at 0°C	EN 744
longitudinal reversion	\leq 2% at 150°C	EN 743
water tightness	no leakage	EN 1053
air tightness	no leakage	EN 1054
elevated temperature cycling	no leakage	EN 1055

2.2 Raw Materials Specifications

Almona products are manufactured using only the highest quality raw materials available from internationally renowned suppliers. The raw material physical properties are checked and approved by independent international and national laboratories. In addition, almona is conducting tests in our state-of-the-art laboratory to ensure compliance to the below specified requirements.

Almona pipes and fittings are manufactured of polypropylene (PP) and mineral reinforced polypropylene (PP-MD) with the following properties:

Characteristics	Requirements of EN 14758-1
melt flow index PP and PP-MD	\leq 1.5 g/10 min
density PP and PP-MD	0.9 g/cm ³ to 1,7 g/cm ³
flexural modulus PP and PP-MD	1,600 MPa to 3,600 MPa
coefficient of linear thermal expansion	0.07 mm/mK to 0.12 mm/mK
thermal conductivity	WK-1 m-1 to 0.6 WK-1 m-1

2.2.1 Fire Resistance

All pipe system components comply with the requirements of DIN 4102 and EN 13501-1 (fire classification B2) for building and construction materials.

The self-ignition temperature is 350 °C. Suitable fire-fighting agents are water, foam, carbon dioxide or powder. In case of fire with PP Pipes, any fire extinguisher may be used. Powder extinguishers are very effective in quenching flames. Water sprays are especially effective in rapid cooling and damping down a fire but are not recommended in the early stages of a fire since they may help to spread the flames.

Other factors will also influence the selection of fire extinguishers eg. proximity of live electrical equipment. Please refer to specific classifications of firefighting extinguishers.

2.2.2 Chemical Resistance

The outstanding chemical resistance of Almona PP-MD systems to a variety of chemicals and solvents, allows their use in a wide range of applications. Our PP-MD systems offer better resistance to corrosive acids, alkaline solutions, solvents, fuels, alcohol and salts than traditional piping systems.

In broad terms, PP-MD systems do not rot, rust, pit, corrode or lose wall thickness through chemical or electrical reaction with the surrounding soil. Also, PP-MD does not normally support the growth of, nor is affected by, algae, bacteria or fungi.

The degree of resistance to a specific chemical will depend on the concentration, temperature, length and type of exposure (i.e. intermittent or continuous) and working pressure, each of which may affect the long-term life of any system. The chemical resistance list provided in Section VII: Appendix shall be used as a guide for evaluating the suitability of our products with the chemical agent is intended to be used.

2.2.3 Temperature Resistance

Almona mineral reinforced polypropylene pipe and fittings systems are suitable for discharges of hot and cold liquids with temperatures ranging between -25°C and 95°C. The integrity of the joints and the materials of Almona systems are confirmed by carrying out the thermal cycling tests, which are included in the relevant ISO and European standards listed on this document (see 2.4 Applicable Standards).

2.3 Quality Assurance

Almona systems provide the highest levels of quality and our target is to exceed the requirements of national and international standards. This is achieved through highly controlled manufacturing processes and the implementation of a state-of-the-art quality control system which covers raw material, pipe and fittings, packing, storage, supply chain and post-sales support.

Our pipe and fittings are produced using the latest generation of machinery operated by trained skilled professionals that are supported by a continuous research and development programme. Deviations on product quality are avoided through stringent quality control checks undertaken by our inhouse quality control laboratory.

This commitment to high quality assurance is further evidenced by accreditation of ISO 9001:2015 Quality Management Systems organization and compliance of all almona products with the appropriate Saudi (SASO), German (SKZ) and International (ISO, DIN) Standards.

2.4 Applicable Standards

Almona mineral reinforced polypropylene pipe and fittings systems comply with the following international standards:

DIN EN 1451	Plastics piping systems for soil and waste discharge (low and high temperature) within the building structure - Polypropylene (PP).
DIN 19560	Pipes and fittings made of polypropylene (PP) for hot water resistant waste and soil discharge systems inside buildings.
EN 14758-1*	Plastics piping systems for non-pressure underground drainage and sewerage Polypropylene with mineral modifiers (PP-MD).
DIN 4102	Requirements of fire behaviour of building materials and building components.
EN 1852 -1	Plastics piping systems for non-pressure underground drainage and sewerage. Polypropylene (PP). Specifications for pipes, fittings and the system.
EN 1852 -2	Plastic piping system for non-pressure drainage and sewerage – Polypropylene (PP) – Guidance for the assessment of conformity.
EN 13476-2	Plastics piping systems for non-pressure underground drainage and sewerage. Structured-wall piping systems. Specifications for pipes and fittings with smooth internal and external surface and the system, Type A.
ONR 20513	Plastics piping systems for non-pressure underground drainage and sewerage Polypropylene with mineral modifiers (PP-MD).
ISO 13967	Thermoplastics fittings - Determination of ring stiffness.
DIN EN 14366	Laboratory measurement of noise from waste water installations.

*All injection moulded fittings have an actual measured ring stiffness of significantly more than 16 kN/m² according to EN ISO 13967.

Section III

3. The high stiffness and low noise mineral filled system concepts

3.1 Stiffness

Almona mineral reinforced polypropylene pipe have a nominal ring stiffness of SN10 and SN16. All reinforced polypropylene injection moulded fittings have an actual measured ring stiffness of significantly more than 16 kN/m² according to EN ISO 13967. The desired strength is achieved by the three-layer design and by reinforcing polypropylene with optimum fillers. Despite its high stiffness, almona pipe and fittings systems have sufficient elasticity to endure all stresses resulting from deformation.

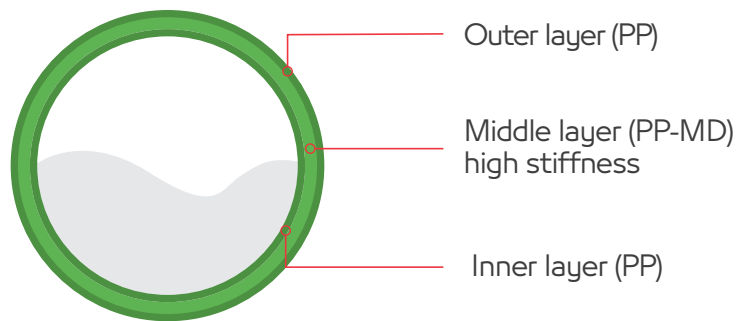

3.2 Elasticity

Elasticity is one of the main advantages of the almona PP-MD sewage pipes system. The pipes are able to change their shape (deflect) in order to redirect external loads to the surrounding soil. Deformations mainly occur after the subsidence of soil, as well as in relation with its movement due to imposed loads such as construction and traffic loads.

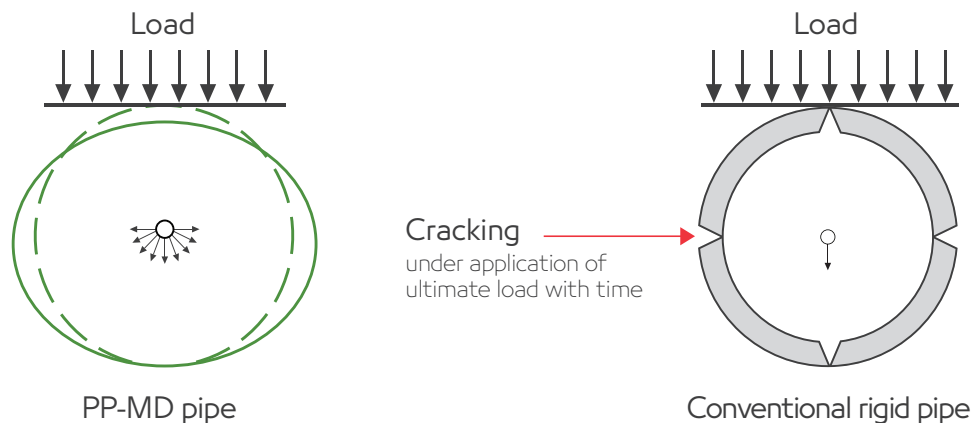

3.3 Low noise

Almona piping systems are specially designed to reduce the environmental noise inside the buildings. Almona 3-layer pipe systems are manufactured using innovative polypropylene reinforced mineral material (PP-MD), which is proved to reduce the noise caused by the water/waste flow inside the system and provide a high degree of sound comfort.

Tests and measurements of noise emitted by the Almona systems were conducted according to the European standard EN 14366 "Laboratory measurement of noise from waste water installations" and system is certified at a noise transmission level of 18 dB at a water flow of 4 l/s using acoustic brackets with rubber lining.

// THE DESIRED STRENGTH IS ACHIEVED BY THE THREE LAYERS DESIGN AND BY REINFORCING POLYPROPYLENE WITH OPTIMUM FILLERS. DESPITE ITS HIGH STIFFNESS, ALMONA PIPE AND FITTINGS SYSTEMS HAVE SUFFICIENT ELASTICITY TO ENDURE ALL STRESSES RESULTING FROM DEFORMATION //

Section IV

4.1. Pipes

Almona mineral reinforced polypropylene pipes range in size from DN 32mm to 200mm.

Pipes SN10 with push-fit socket and 3-lip rubber sealing ring

Material: mineral reinforced polypropylene

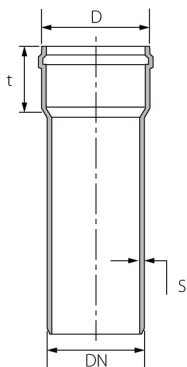

Code	Ring Stiffness kN/m ²	DN (mm)	D (mm)	S (mm)	t (m)	Pipe length (m)
SN10		32	45	3.4	42	6
SN10		40	55	3.4	44	6
SN10		50	65	3.4	46	6
SN10		75	90	3.4	49	6
SN10		90	107	3.4	54	6
SN10		110	130	3.4	65	6
SN10		125	149	3.9	72	6
SN10		160	186	4.9	75	6
SN10		200	228	6.2	108	6

Pipes SN16 with push-fit socket and 3-lip rubber sealing ring

Material: mineral reinforced polypropylene

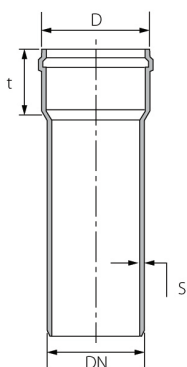

Code	Ring Stiffness kN/m ²	DN (mm)	D (mm)	S (mm)	t (m)	Pipe length (m)
SN16		32	45	3.4	42	6
SN16		40	55	3.4	44	6
SN16		50	65	3.4	46	6
SN16		75	90	3.4	49	6
SN16		90	107	3.4	54	6
SN16		110	130	3.4	65	6
SN16		125	149	3.9	72	6
SN16		160	186	4.9	75	6
SN16		200	228	6.2	108	6

4.2 Fittings

Almona mineral reinforced polypropylene pipes ranging in size from DN 32mm to 200mm.

Bend 87,5°

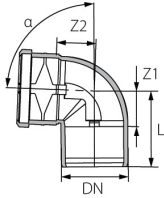

Code	DN (mm)	L (mm)	Z1 (mm)	Z2 (mm)
	50	97	39	52
	75	125	60	69
	110	158	82	93
	160	195	95	108

Bend 45°

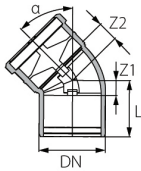

Code	DN (mm)	L (mm)	Z1 (mm)	Z2 (mm)
	50	75	17	27
	75	86	21	33
	110	110	34	41
	160	149	49	59

Reducer

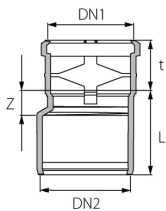

Code	DN 1 (mm)	DN 2 (mm)	L (mm)	t (mm)	Z (mm)
	32	50			
	50	75			
	50	110			
	75	110			
	110	160	44	69	151

Double Socket

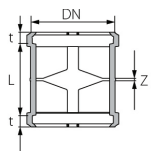

Code	DN (mm)	L (mm)	t (mm)	Z (mm)
	50	65	20	3
	75	75	22	3
	110	85	28	3
	160	108	38	4

Tee 87,5°

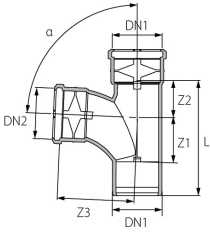

Code	DN 1 (mm)	DN 2 (mm)	Z1 (mm)	Z2 (mm)	Z3 (mm)	L (mm)
	50	50	38	40	83	136
	75	75	60	54	105	179
	110	110	82	73	134	231
	160	110	72	78	136	250
	160	160	95	103	155	298

Branch 45°

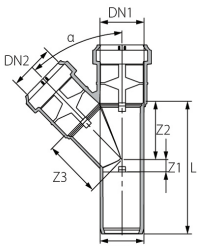

Code	DN 1 (mm)	DN 2 (mm)	Z1 (mm)	Z2 (mm)	Z3 (mm)	L (mm)
	50	50	16	68	68	142
	75	75	26	98	98	189
	110	110	34	141	141	251
	160	110	19	171	175	290
	160	160	53	205	205	358

Double Branch 45°

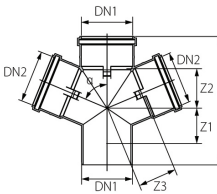

Code	DN 1 (mm)	DN 2 (mm)	Z1 (mm)	Z2 (mm)	Z3 (mm)	L (mm)
	110	110	34	141	141	320

Double Branch 87.5°

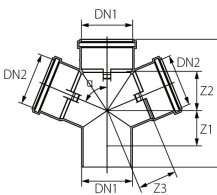

Code	DN 1 (mm)	DN 2 (mm)	Z1 (mm)	Z2 (mm)	Z3 (mm)	L (mm)
	110	110	82	73	93	300

End Cap

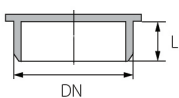

Code	DN (mm)	L (mm)
	110	50
	160	70

Section V

5. Installation

5.1 Typical Installation

Almona mineral reinforced systems are suitable for being installed inside and outside buildings together with being laid underground.

5.2 Installation of pipes and fittings within the building

5.2.1 Pipe and fittings fixing

For installation inside buildings the pipe systems must be securely fixed using rubber lined steel clamps. The clamps should be appropriate for the given outer diameter and to completely circumvent the pipe. If no inner lining is used inside the clamp, then the inside edge of the clamp must be rounded off and the inside surface must be smooth. Inner linings made of PVC or pipe hooks must not be used. Fixed points are achieved by completely tightening the pipe clamps in a piping system. The clamps must be positioned so that each pipe length is prevented from slipping. The fixed clamps must be positioned directly behind the socket for pipe with sockets. Fittings or groups of fittings must always be laid out as fixed points.

Over tightening should be avoided to allow for thermal expansion movements. Distances between pipe supports are shown in the following table:

Size	Maximum Support Distance	
	Vertical (m)	Horizontal (m)
32	1.2	0.5
40	1.2	0.5
50	1.5	0.5
75	2.0	0.8
90	2.0	0.9
110	2.0	1.1
125	2.0	1.2
160	2.0	1.6

5.2.2 Expansion Compensation

To accommodate the movement of the pipes with changes in temperature, the push-fit connections shall be carefully made (see Section V, 5.2.6 Jointing). Regular checks should be made to ensure that the expansion allowance has not been lost.

5.2.3 Change of Direction

To improve hydraulic flow and to prevent high noise caused by the discharge flow during operation, abrupt directional changes shall be avoided. For any 90° change of direction in the transition area leading from a vertical to a horizontal alignment, it is recommended to use two 45° elbow with 250 mm minimum length of connecting pipe between them rather than a 90° elbow.

5.2.4 Installation in Masonry Structures

Slots in masonry should allow stress and tension free pipe installation. If the pipes must be embedded in mortar without the use of mortar carriers or enclosures, then the pipes and fittings must be completely wrapped in flexible material, such as cardboard, mineral or glass wool. At areas where high temperatures can occur, appropriate measures must be taken to protect the pipes (insulation of heat carrying lines e.g. heating lines). Horizontally laid pipelines (connecting or collecting lines) which, for example, serve as a connection for multiple wall fixture elements should have a wrapping along their entire length. Linear expansion of the pipes and fixtures must not be hindered.

5.2.5 Installation in Ceilings and Floors

Laying pipes in ceilings must be done so that they are moisture proof and sound proof. The appropriate wrapping material must be used. In case of floors using poured asphalt, the pipeline parts must be protected by using protective pipes or by wrapping with heat insulating materials. If fire protection requirements are placed on ceilings, then the appropriate fire protection steps are to be observed.

When installing pipes in open spaces (such as basements and parking garages etc.), above suspended ceilings or behind screen walls, prevent any contact of other building components (such as suspended ceiling, electrical, water, ventilation and air conditioning systems etc.) with the pipes.

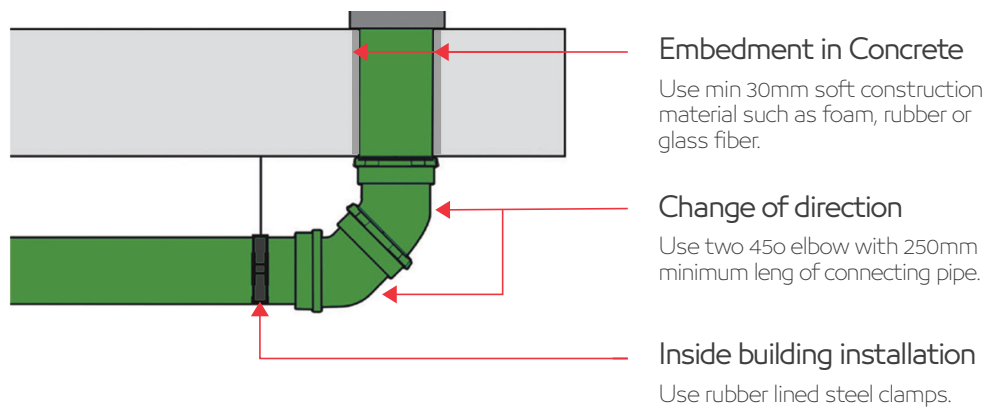

5.2.6 Embedment in Concrete

Almona pipes and fittings can be embedded directly into concrete but length changes of the pipes due to thermal expansion must be taken into consideration. Additionally, for pipes traversing walls and ceilings, a space of at least 30 mm shall be maintained between the pipe and any rigid material. If the spaces around the pipes traversing walls and floors must be filled, use only soft construction materials such as foam, rubber or glass fiber. In every case, pipes and fittings shall be fastened properly in order to avoid any change in their position during concrete pouring. The pipe ends shall be closed and the gap between pipe and socket to be sealed with adhesive tape in order to prevent cement from seeping inside the socket gap.

5.2.7 Fire Protection Collars



Fire protection collars are recommended to be used when installing the pipes and fittings on walls and ceilings and where active protection measures must be taken. In case of fire or heat, a special fireproof laminate inside the collar begins to expand and creates a protective seal against transmission of fire inside the system.

5.2.8 Jointing

The following steps should be followed during the jointing process of almona pipes and fittings.

Step 1: Cut, chamfer and deburr: Cut the pipe square with a commercial pipe cutter or fine-toothed saw. Ensure that the pipe is secured properly prior to cutting. Cut pipe at a 90° angle from the pipe axis. Chamfer the pipe end with a suitable beveling machine and de-burr the inner diameter of the pipe. For connections to push-fit socket pipe systems, taper the pipe ends with a tapering tool or a coarse file at an angle of approximately 15°.

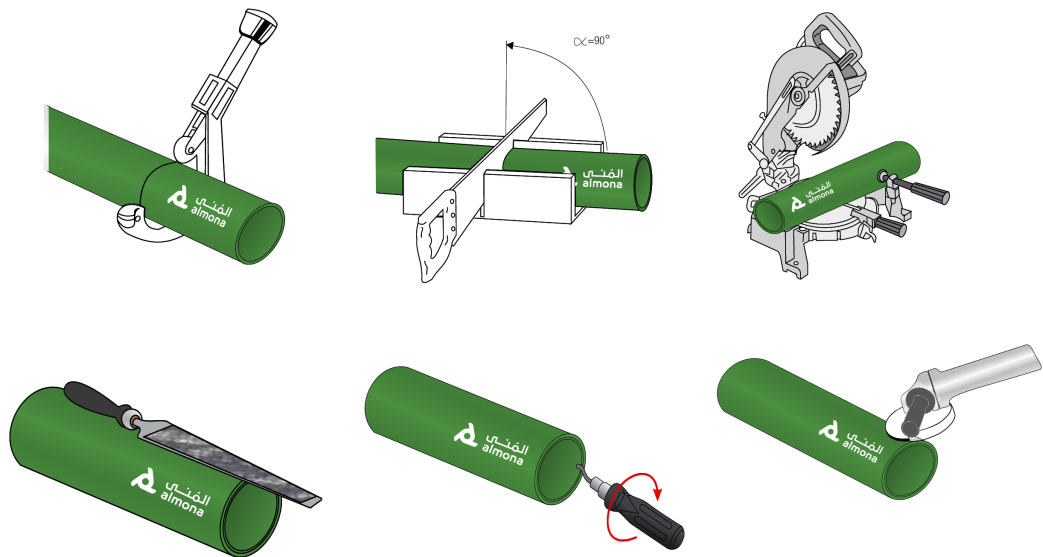

Step 2: Clean, lubricate, mark and push-fit: Clean the spigot and socket from dust, grit, grease and make sure surfaces are as dry as possible. Use small amount of special lubricant to moisten chamfered pipe and then insert pipe into the socket without the seal ring in place and mark pipe when it's fully inserted. Place seal ring in groove of the socket ensuring that seal is the correct way round. Apply lubricant to the pipe, fitting and seal ring. Push-fit the pipe to full socket depth and then withdraw the pipe 10mm to allow for expansion. Ensure witness mark is visible to ensure that the pipe is not accidentally pulled out.

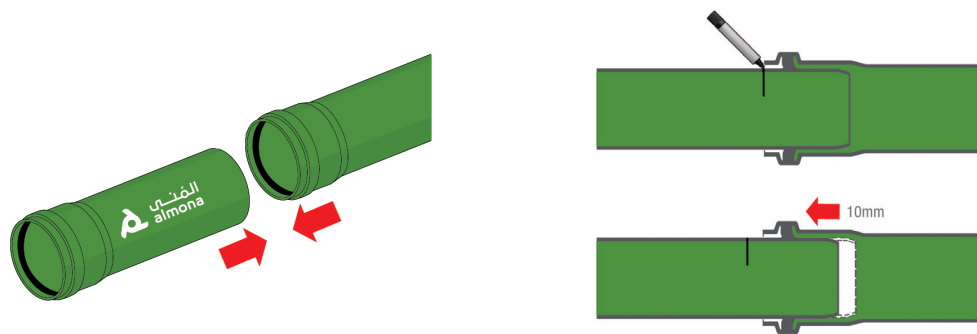

5.2.9 Subsequent Installation of Pipes and Fittings

The connection to an existing line can be done using branches or couplers.

- When using couplers, a sufficiently long pipe length (pipe length approx. 2 x outside diameter) is cut out, the ends of the pipe are then to beveled and the branch connector is then installed. The remaining space in the line is closed off by inserting an appropriately long pipe length and two couplers. The couplers have to be secured against slipping.

- If long sockets are used, then a length of pipe that equals the length of the fitting plus the insert depth is cut out. The long socket is then inserted all the way to the end and the fitting is installed by using a coupler. Afterwards the spigot end of the long socket is to be inserted in the other socket end of the fitting. The couplers have to be secured against slipping.

5.3 Installation of pipes below the ground

For almona PP-MD sewage pipes and fittings systems to function as designed, it is important to install the pipe to the proper line and grade. The width of the trench for the system installation depends on the pipe diameter, backfill material and the method of compaction. The Engineer shall design the trench widths based on an evaluation of the in-situ materials, the quality and compaction level of the backfill, the design loads and the compaction equipment to be used, according to the project's or governing agency's specifications. The following recommendations apply for utilization and installation of almona which serve as non-pressure underground pipes for drainage and sewage, according to EN 1851-2, EN 13476-2 :2007 (Type A1) ONR 20513:2011 and EN 1610.

- Under normal load conditions, installation deformation is allowed up to 6%.
- Under special conditions, such as sections where compaction machinery cannot be used, deformation shall not exceed 8%.
- Extreme deformation due to conditions such as post installation subsidence shall not exceed 15%.

5.3.1 Support and embedding

Once the trench is excavated, a stable, compacted and uniform bedding shall be provided for the pipe and any protruding features of its joints and/or fittings to equalize load distribution along the invert of the pipe. Under normal conditions the depth of the lower bedding must be at least 100 mm, with rock or consolidated ground at least 150 mm. During the construction period the trench shall be kept dry by means of drainage, lowering the groundwater or other methods.

Backfill shall be considered as part of the structural design of the sewerage network, bearing in mind that the purpose of the backfill envelope is to provide long-term support to the pipe. In a properly constructed backfill envelope, the loads are distributed across the crown of the pipe to the material along the sides and then to the pipe bedding and foundation. This load arching effect reduces the total load applied to the pipe. The load-carrying capacity of a pipe/backfill system will be determined by a combination of the backfill material, the level of compaction, and the placement of the backfill material. However, the type of application may also influence what type of backfill is required.

The thickness of the upper embedding layer shall be carried out in such a manner that the structural analysis conditions are fulfilled and a support angle of 180° is achieved, i.e. generally $0.5 \times OD$ (outer diameter). If for any structural reasons, additional steps for the installation be considered essential, a concrete slab above backfill envelope area is recommended instead of a concrete jacket for load distribution purposes. Settlement is only permitted if technically unavoidable. Avoid high loads during the construction, such as driving on the covered pipeline with heavy construction equipment or vehicles.

5.3.2 Cutting and beveling

If necessary, pipes may be cut to length with a suitable plastic pipe cutter or fine-toothed saw. Cuts shall be made at right angles to the pipe axis. The cutting edges shall be trimmed. The pipe ends shall be beveled at an angle of approximately 15° , as in the illustration, using either a suitable tool for beveling or a coarse file.

5.3.3 Jointing

(please refer to Section V, 5.2.6)

5.3.4 Connection to chambers

Connections to structures such as chambers shall be carried out using chamber inlets, where a circular hole of at least 20mm greater than the pipe outer diameter shall be formed in the structure wall. Sealing of the annulus between the chamber wall and the sewer pipe shall be carried out by means of a rubber sealing ring or similar arrangement.

Beveling Dimensions									
DN/OD	32	40	50	75	90	110	125	160	200
b (mm)	3,5	3,5	3,5	3,5	4,5	4,5	5,0	6,0	6,0

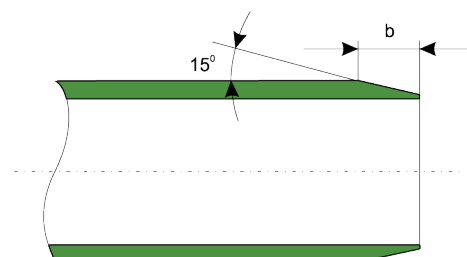

Section VI

6. Storage and Handling of pipes and fitting

6.1 Storage

During storage almona systems without a UV black protection layer shall be protected from extended exposure to direct sunlight. This will prevent the effects of ultraviolet-rays and heat buildup:

- If the pipe is stored in racks, it should be continuously supported along its length.
- Pipes shall be stored inside to prevent damage.
- When pipes are stacked, ensure that the weight of upper units does not cause deformation to pipes in the bottom of the stack.
- Pipes shall not be stored close to heat sources or hot objects.
- Pipes and fittings shall always be protected from dirt and moisture.

6.2 Transportation

Almona systems proves its robustness during transport and at the construction site thanks to its three-layer structure incorporating an impact-resistant and shock-proof outer layer. However, the pipes shall be handled with reasonable care to avoid breakage or damage.

- The pipe shall never be pushed or thrown from a delivery truck.
- The pipe without UV black protection layer shall be protected from direct sunlight at all times.
- The pipe shall be kept away from sharp objects (rocks, irons...etc.) to prevent damage.
- Lifting of pipes requires extra care as the extended pipe weight can cause excessive deformation and can lead to cracking or breakage.

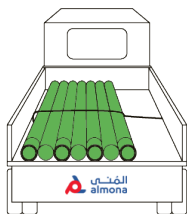

- Lay pipes flat on the tray truck
- Do not throw pipes on the tray

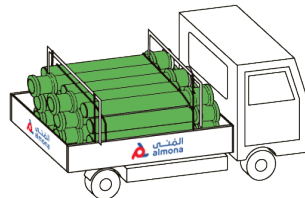

- Keep pipes strapped down in order not to roll around and to remain supported.
- Do not overtighten with ratchet
- Unsupported pipes can bend

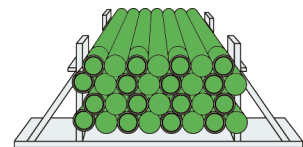

- If pipes are stored in racks, they shall be continuously supported along their length.
- Ensure that the weight of upper units do not cause deformation to pipes at the bottom of the stack.

APPENDIX

7. Chemical resistance list PP-MD

The data in this list is intended only as a guide. Considerable deviations can occur depending on type of exposure and contamination of the chemical medium. Almona cannot be held liable for any damages. No warranty can be derived. concerning the data mentioned.

Chemical or Product	Concentration	Temperature °C		
		20	60	100
Acetic acid	up to 40%	S	S	-
Acetic acid	50%	S	S	L
Acetic acid, glacial	>96%	S	L	NS
Acetic anhydride	100%	S	-	-
Acetone	100%	S	S	-
Aceptophenone	100%	S	L	-
Acrylonitrile	100%	S	-	-
Air	-	S	S	S
Allyl alcohol	100%	S	S	-
Almond oil	-	S	-	-
Alum	Sol	S	S	-
Ammonia, aqueous	Sat. sol	S	S	-
Ammonia, dry gas	100%	S	-	-
Ammonia, liquid	100%	S	-	-
Ammonium acetate	Sat. sol	S	S	-
Ammonium chloride	Sat. sol	S	S	-
Ammonium fluoride	up to 20%	S	S	-
Ammonium hydrogen carbonate	Sat. sol	S	S	-
Ammonium metaphosphate	Sat. sol	S	S	S
Ammonium nitrate	Sat. sol	S	S	S
Ammonium persulphate	Sat. sol	S	S	-
Ammonium phosphate	Sat. sol	S	-	-
Ammonium sulphate	Sat. sol	S	S	S
Ammonium sulphide	Sat. sol	S	S	-
Amyl acetate	100%	L	-	-
Amyl alcohol	100%	S	S	S
Aniline	100%	S	S	-
Apple juice	-	S	-	-
Aqua regia	HCl/HNOF ₃	NS	NS	NS
Barium bromide	Sat. sol	S	S	S
Barium carbonate	Sat. sol	S	S	S
Barium chloride	Sat. sol	S	S	S
Barium hydroxide	Sat. sol	S	S	S
Barium sulphide	Sat. sol	S	S	S
Beer	-	S	S	-

Legend

S = Satisfactory, L = Limited, NS = Not Satisfactory, - = No testing, unknown

Chemical or Product	Concentration	Temperature °C		
		20	60	100
Benzene	100%	L	NS	NS
Benzoic acid	Sat. sol	S	S	-
Benzyl alcohol	100%	S	L	-
Borax	Sol	S	S	-
Boric acid	Sat. sol	S	-	-
Boron trifluoride	Sat. sol	S	-	-
Bormine, gas	-	NS	NS	NS
Bromine, liquid	100%	NS	NS	NS
Butane, gas	100%	S	-	-
Butanol	100%	S	L	L
Butyl acetate	100%	L	NS	NS
Butyl glycol	100%	S	-	-
Butil fenol	100%	S	L	L
Calcium carbonate	Sat. sol	S	S	S
Calcium chlorate	Sat. sol	S	S	-
Calcium chlorate	Sat. sol	S	S	S
Calcium hydroxide	Sat. sol	S	S	S
Calcium hypochlorite	Sol	S	-	-
Calcium nitrate	Sat. sol	S	S	-
Camphor oil	-	NS	NS	NS
Carbon dioxide, dry gas	-	S	S	-
Carbon dioxide, wet gas	-	S	S	-
Carbon disulphide	100%	S	NS	NS
Carbon monoxide, gas	-	S	S	-
Carbon tetrachloride	100%	NS	NS	NS
Castor oil	100%	S	S	-
Caustic soda	Up to 50%	S	L	L
Chlorine, aqueous	Sat. sol	S	L	-
Chlorine, dry gas	100%	NS	NS	NS
Chlorine, liquid	100%	NS	NS	NS
Chloroacetic acid	100%	S	-	-
Chloroethanol	100%	S	-	-
Chloroform	100%	L	NS	NS
Chlorosulphonic acid	100%	NS	NS	NS
Chrome alum	Sol	S	S	-
Chromic acid	up to 40%	S	L	NS
Citric acid	Sat. sol	S	S	S
Coconut oil	-	S	-	-
Copper (II) chloride	Sat. sol	S	S	-
Copper (II) nitrate	Sat. sol	S	S	S
Copper (II)	Sat. sol	S	S	-
Corn oil	-	S	L	-
Cottonseed oil	-	S	S	L
Cresol	90%	S	-	-
Cyclohexane	100%	S	-	-
Cyclohexanol	100%	S	L	-
Cyclohexanone	100%	L	NS	NS

Legend

S = Satisfactory, **L** = Limited, **NS** = Not Satisfactory, **-** = No testing, unknown

Chemical or Product	Concentration	Temperature °C		
		20	60	100
Decalin	100%	NS	NS	NS
Dextrin	Sol	S	S	-
Dextrin Dextrose	Sol	S	S	S
Dibutyl phthalate	100%	S	L	NS
Dichloroacetic acid	100%	L	-	-
Dichloroethytene (A & B)	100%	L	-	-
Diethanolamine	100%	S	-	-
Diethyl ether	100%	S	L	-
Diethylene glycol	100%	S	S	-
Diglycolic acid	100%	S	-	-
Dimethyl amine, gas	-	S	-	-
Dimethyl formamide	100%	S	S	-
Diethyl phthalate	100%	L	L	-
Dioxane	100%	L	L	-
Distilled water	100%	S	S	S
Ethyl alcohol	Up to 95%	S	S	S
Ethyl chloride, gas	-	NS	NS	NS
Ethylene chloride	-	L	L	-
Ethyl ether	100%	S	L	-
Ethylene glycol	100%	S	S	S
Ethanolamine	100%	S	-	-
Ethyl acetate	100%	L	NS	NS
Ferric chloride	Sat. sol	S	S	S
Ferric chloride	40%	S	-	-
Formic acid	10%	S	S	L
Formic acid	85%	S	NS	NS
Formic acid, anhydrous	100%	S	L	L
Fructose	Sol	S	S	S
Fruit juice	-	S	S	S
Gasoline. petrol	-	NS	NS	NS
Gelatine	-	S	S	-
Glucose	20%	S	S	S
Glycerine	100%	S	S	S
Glycolic acid	30%	S	-	-
Heptane	100%	L	NS	NS
Hexane	100%	S	L	-
Hydrobromic acid	higher 48%	S	L	NS
Hydrochloric acid	higher 20%	S	S	S
Hydrochloric acid	30%	S	L	L
Hydrochloric acid	From 35-36%	S	-	-
Hydrofluoric acid	Dil.sol	S	-	-
Hydrofluoric acid	40%	S	-	-
Hydrogen	100%	S	-	-
Hydrogen chloride	100%	S	S	-
Hydrogen peroxide	Up to 10%	S	-	-
Hydrogen peroxide	Up to 30%	S	L	-
Hydrogen sulphide	100%	S	S	-

Legend

S = Satisfactory, **L** = Limited, **NS** = Not Satisfactory, **-** = No testing, unknown

Chemical or Product	Concentration	Temperature °C		
		20	60	100
Iodine, in alcohol	-	S	-	-
Isoctane	100%	L	NS	-
Isopropyl alcohol	100%	S	S	S
Isopropyl ether	100%	L	-	-
Lactic acid	-	S	S	-
Lanoline	-	S	L	-
Linseed oil	-	S	S	S
Magnesium carbonate	Sat. sol	S	S	S
Magnesium chloride	Sat. sol	S	S	-
Magnesium hydroxide	Sat. sol	S	S	-
Magnesium sulphate	Sat. sol	S	S	-
Maleic acid	Sat. sol	S	S	-
Mercury (II) chloride	Sat. sol	S	S	-
Mercury (II) cyanide	Sat. sol	S	S	-
Mercury (I) nitrate	Sol	S	S	-
Mercury	100%	S	S	-
Methyl acetate	100%	S	S	-
Methyl alcohol	5%	S	L	-
Methyl amine	Up to 32%	S	-	-
Methyl bromide	100%	NS	NS	NS
Methyl ethyl ketone	100%	S	-	-
Methylene chloride	100%	L	NS	NS
Milk	-	S	S	S
Monochloroacetic acid	<85%	S	S	-
Naphtha	-	S	NS	NS
Nickel chloride	Sat. sol	S	S	-
Nickel nitrate	Sat. sol	S	S	-
Nickel sulphate	Sat. sol	S	S	-
Nitric acid	Up to 30%	S	NS	NS
Nitric acid	40 to 50%	L	NS	NS
Nitric acid	-	NS	NS	NS
Nitrobenzene	100%	S	L	-
Oleic acid	100%	S	L	-
Oleum	-	S	L	-
Olive oil	-	S	S	L
Oxalic acid	Sat. sol	S	L	NS
Oxygen, gas	-	S	-	-
Parafin oil (FL65)	-	S	L	NS
Peanut oil	-	S	S	-
Peppermint oil	-	S	L	-
Perchloric acid	(2N) 20%	S	-	-
Petroleum ether	-	L	L	-
Phenol	5%	S	S	-
Phenol	90%	S	-	-
Phosphine, gas	Up to 85%	S	S	S
Phosphorus oxychloride	100%	L	-	-

Legend

S = Satisfactory, L = Limited, NS = Not Satisfactory, - = No testing, unknown

Chemical or Product	Concentration	Temperature °C		
		20	60	100
Picric acid	Sat. sol	S	-	-
Potassium bicarbonate	Sat. sol	S	S	S
Potassium borate	Sat. sol	S	S	-
Potassium bromate	Up to 10%	S	S	-
Potassium bromide	Sat. sol	S	S	-
Potassium carbonate	Sat. sol	S	S	-
Potassium chlorate	Sat. sol	S	S	-
Potassium chlorite	Sat. sol	S	S	-
Potassium chromate	Sol	S	S	-
Potassium cyanide	Sat. Sol	S	-	-
Potassium dichromate	Sat. Sol	S	S	S
Potassium ferricyanide	Sat. Sol	S	S	-
Potassium fluoride	Up to 50%	S	S	-
Potassium hydroxide	Sat. Sol	S	S	S
Potassium iodide	Sat. Sol	S	-	-
Potassium nitrate	10%	S	S	-
Potassium perchlorate	(2N) 30%	S	S	-
Potassium permanganate	Sat. sol	S	-	-
Succinic acid	Up to 10%	S	S	S
Sulphuric acid	100%	S	-	-
Sulphur dioxide	100%	S	S	-
Sulphur acid	10 to 30%	S	S	-
Sulphur acid	50%	S	L	L
Sulphur acid	96%	S	L	NS
Sulphur acid	98%	L	NS	NS
Sulphurous acid	Up to 30%	S	-	-
Tartaric acid	Sat.sol	S	S	-
Tetrahydrofuran	100%	L	NS	NS
Tetralin	100%	NS	NS	NS
Thiophene	100%	S	L	-
Tin (IV) chloride	Sol	S	S	-
Tin (II) chloride	Sat. Sol	S	S	-
Toluene	100%	S	-	-
Trichloroacetic acid	Up to 50%	S	S	-
Trichloroethylene	100%	NS	NS	NS
Triethanolamine	Sol	S	-	-
Turpentine	-	NS	NS	NS
Urea	Sat. Sol	S	S	-
Vinegar	-	S	S	-
Water brackish, mineral, potable	-	S	S	S
Whiskey	-	S	S	-
Wines	100%	S	-	-
Xylene	100%	NS	NS	NS
Yeast	Sol	S	S	S
Zinc chloride	Sat. Sol	S	S	-
Zinc sulphate	Sat. Sol	S	S	-

Legend

S = Satisfactory, **L** = Limited, **NS** = Not Satisfactory, **-** = No testing, unknown

“ ALMONA SYSTEMS PROVIDE THE HIGHEST LEVELS OF QUALITY AND OUR TARGET IS TO EXCEED THE REQUIREMENTS OF NATIONAL AND INTERNATIONAL STANDARDS. THIS IS ACHIEVED THROUGH HIGHLY CONTROLLED MANUFACTURING PROCESSES AND THE IMPLEMENTATION OF A STATE-OF-THE-ART QUALITY CONTROL SYSTEM WHICH COVERS RAW MATERIAL, SYSTEM MANUFACTURE, PACKING, STORAGE, SUPPLY CHAIN AND POST-SALES SUPPORT ”



Saudi made

صنع بالسعودية



High quality

جودة عالية



almonaplast.com



T +966 11 410 2326
E info@almonaplast.com

P.O. Box: 270736 Riyadh 11352
Kingdom of Saudi Arabia

شركة مصنع المنى للمنتجات البلاستيكية
Almona Plastic Products Ltd. Co.